

# Doro 6520

English

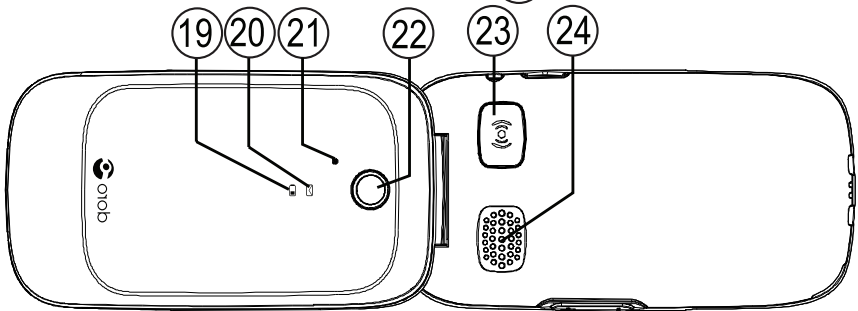

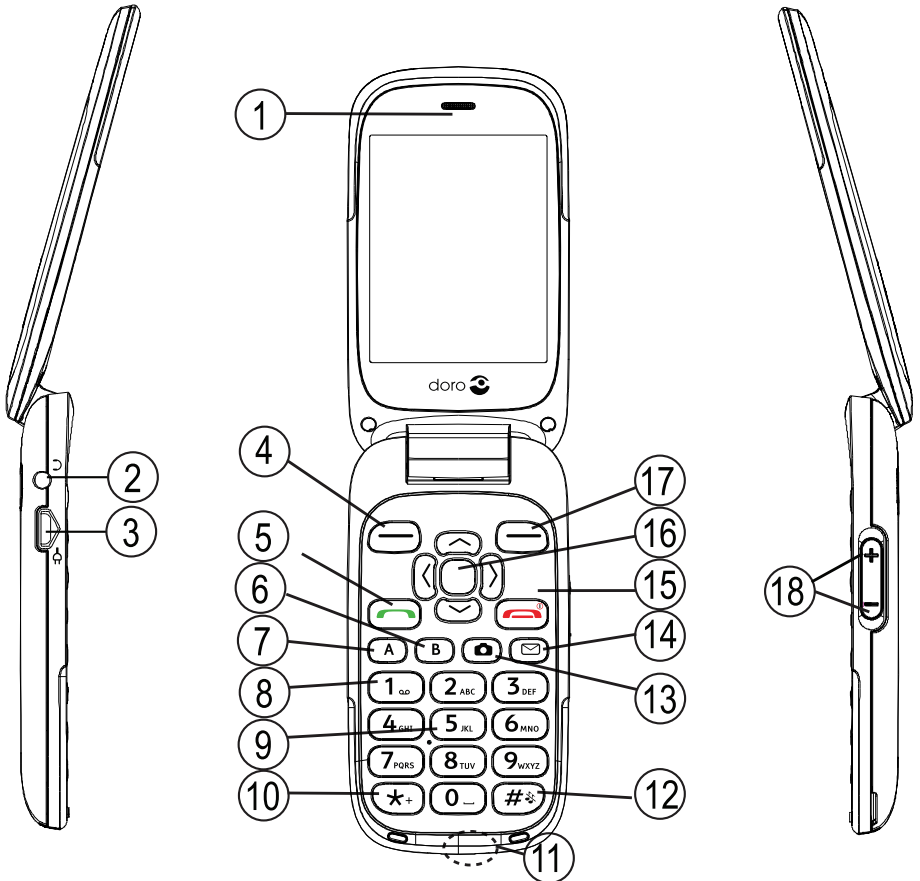

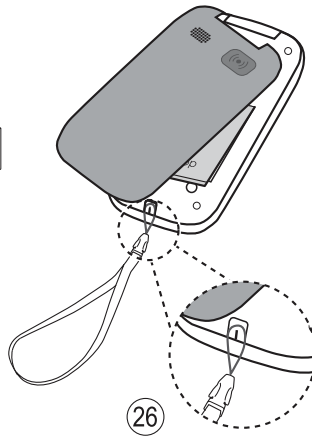
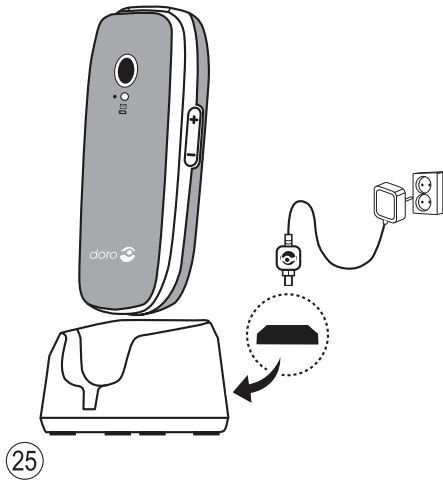











The items supplied with your phone might vary depending on the software and accessories available in your region or offered by your service provider. You can obtain additional accessories from your local Doro dealer. The supplied accessories provide the best performance with your phone.

- |   |   |
|---|---|
| <ol style="list-style-type: none"> <li>1. Earpiece</li> <li>2. Headset socket</li> <li>3. Charging socket</li> <li>4. Left selection button</li> <li>5. Call button</li> <li>6. Speed dial A</li> <li>7. Speed dial B</li> <li>8. Voice mail</li> <li>9. Microphone</li> <li>10. International prefix/Symbols</li> <li>11. Strap mount eyelet (strap not included)</li> <li>12. Input method/Silent</li> <li>13. Camera shortcut</li> <li>14. Message shortcut</li> <li>15. End call/<b>Power on/off</b></li> </ol> | <ol style="list-style-type: none"> <li>16. Arrow buttons/Navigation buttons</li> <li>17. Right selection button</li> <li>18. Volume control</li> <li>19. Red light = Battery level low/Charging</li> <li>20. Green light = New message/ Missed call</li> <li>21. Second microphone</li> <li>22. Camera lens</li> <li>23. Assistance button</li> <li>24. Loudspeaker</li> <li>25. Charging stand</li> <li>26. Strap mount eyelet (strap not included)</li> </ol> |
|---|---|

# Contents

Congratulations on your purchase .....	1
Get started .....	1
Insert SIM card, memory card and the battery .....	1
Charge the phone .....	2
Get to know your phone .....	3
Assistive functions .....	3
Turn the phone on and off .....	3
Start-up wizard .....	3
Phone indicators .....	4
How to navigate the phone  .....	4
Enter text  .....	5
Volume control .....	6
Hearing aid compatible .....	7
Phone settings .....	8
Calls .....	10
Make a call .....	10
Call from the phonebook .....	10
Receive a call .....	10
Call information .....	10
Call options .....	11
Speed dial  .....	11
SOS calls .....	12
Call log .....	12
Call settings .....	12
Phonebook .....	15
Add contact .....	15
Manage phonebook contacts .....	16
Phonebook settings .....	17
ICE (In Case of Emergency)  .....	18
Assistance button  .....	19
Make an assistance call .....	20
Activation .....	20
Number list .....	21
Activate text messages (SMS) .....	21
Assistance settings .....	22

---

Messages.....	22
Create and send text message (SMS) .....	22
Create and send picture message (MMS) .....	23
Create and send voice message .....	24
Create and send e-mail.....	24
Inbox, Outbox and Sent.....	26
Message settings .....	27
Camera.....	32
Camera.....	32
Video camera.....	33
Picture gallery and Video gallery .....	33
Camera settings .....	34
Connectivity .....	35
Bluetooth® .....	35
Internet profile .....	36
Mobile data, data counter and data roaming .....	37
Network setup .....	38
Connect the phone to a computer .....	39
Sound & Display .....	39
Audio setup  .....	40
Tone setup (ringtone) .....	40
Ringtone volume  .....	40
Silent .....	40
Alert type .....	41
Extra tone.....	41
Main menu.....	41
Wallpaper.....	41
Text size  .....	42
Idle display.....	42
Themes  .....	42
LCD backlight.....	42
Brightness  .....	42
My Doro Manager®.....	43
Create account .....	43
Log in/Log out .....	43
Options.....	43
Sync. intervals .....	44
Account details .....	44

---

File manager .....	44
Internet.....	45
Use the web browser.....	45
Use the Facebook application .....	46
More .....	47
FM radio .....	47
Calculator.....	49
Games .....	49
Status .....	50
Organiser.....	50
Alarm .....	50
Calendar.....	50
Daily reminder .....	51
Notes .....	52
Weather.....	52
Additional functions .....	52
Display status symbols .....	52
Display main symbols .....	53
Reset settings.....	54
Safety instructions.....	54
Network services and costs.....	54
Operating environment .....	54
Medical units .....	55
Areas with explosion risk .....	55
Li-ion battery .....	55
Protect your hearing.....	56
Emergency calls.....	56
GPS/Location based functions .....	56
Vehicles.....	56
Protect your personal data .....	57
Malware and viruses .....	57
Care and maintenance .....	58
Warranty.....	59
Specifications .....	59
Copyright and other notices.....	59
Hearing aid compatibility .....	61
Specific Absorption Rate (SAR) .....	61
Correct disposal of this product .....	62

---

Correct disposal of batteries in this product .....	62
Declaration of Conformity .....	63
FCC .....	63
FCC notice .....	63
RF exposure information (SAR) .....	63

## Congratulations on your purchase

Enjoy an elegant camera phone made simple, with convenient ways to communicate and enjoy access to e-mail and the Internet for staying connected everywhere. Share photos and listen to your favourite MP3 music or FM radio. Other practical features include weather, reminders, wake-up alarm, vibrating ringer and more. For more information about accessories or other Doro products please visit [www.doro.com](http://www.doro.com).

## Get started

### Insert SIM card, memory card and the battery

#### IMPORTANT!

Turn off the phone and disconnect the charger before removing the battery cover.

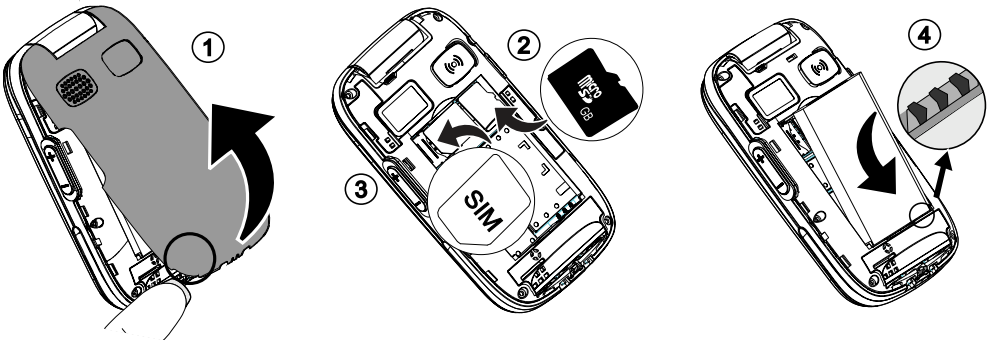

1. Remove the battery cover. Be careful not to damage your fingernails when you remove the cover. Do not bend or twist the cover excessively as it may be damaged. Remove the battery if it is already installed.
2. Optional: Locate the SD card holder and gently slide the card in the holder. The device works with or without a SD card installed. Compatible card type: microSD, microSDHC.
3. Locate the SIM card holder and gently slide the card in the holder. See the label right next to the holder for guidance on how to insert the card. This device accepts micro SIM or 3FF SIM card. If you have problem to remove/replace the SIM card, use adhesive tape on the exposed part of the SIM card to pull it out.



4. Insert the battery by sliding it into the battery compartment with the contacts facing downwards to the right. Replace the battery cover.

### IMPORTANT!

This device accepts micro SIM or 3FF SIM card. Use of incompatible SIM cards may damage the card or the device, and may corrupt data stored on the card.

### IMPORTANT!

Use only compatible memory cards for use with this device. Compatible card type: **microSD, microSDHC**. Incompatible cards may damage the card itself, the device and corrupt data stored on the card. Depending on the market some phones may have a pre-installed memory card.





## Charge the phone



### CAUTION

Only use batteries, chargers and accessories that have been approved for use with this particular model. Connecting other accessories may be dangerous and may invalidate the phone's type approval and warranty.

When the battery is running low,  is displayed and a warning signal is heard.

1. Connect the mains adapter to a wall socket and to the charging socket . The battery charge indicator is animated while charging. It takes approximately 3 hours to fully charge the battery. When the charger is connected to the phone,  is displayed briefly, and  when it is disconnected.
2. When charging is completed,  is displayed on the screen. If the phone is turned off when the charger is connected to the phone only the battery charge indicator will be shown on the display.

**Note!** To save power the LCD backlight goes off after a while. Press any button to illuminate the display. Full battery capacity will not be reached until the battery has been charged 3–4 times. Batteries degrade over time, which means that call time and standby time will normally decrease with regular use.

## Save energy

When you have fully charged the battery and disconnected the charger from the device, unplug the charger from the wall socket.

## Get to know your phone

### Assistive functions

Use the symbols below to guide you through supporting sections in the manual.



Seeing



Handling





Hearing



Safety

### Turn the phone on and off

1. Press and hold  on the phone to turn it on or off. Confirm with **Yes** to power off.
2. If the SIM card is valid but protected with a PIN code (Personal Identification Number), **PIN** is displayed. Enter the PIN code and press **OK** ( upper left corner of keypad). Delete with **Clear** ( upper right corner of keypad).

**Note!** If PIN and PUK codes were not provided with your SIM card, please contact your service provider.

**Attempts: #** shows the number of PIN attempts left. When no more attempts remain, **PIN blocked** is displayed. The SIM card must then be unlocked with the PUK code (Personal Unblocking Key).

1. Enter the PUK code and confirm with **OK**.
2. Enter a new PIN code and confirm with **OK**.
3. Re-enter new PIN code and confirm with **OK**.

### Start-up wizard

When starting the phone for the first time, you can use the Start-up wizard to set some basic settings.

- Press **Yes** to change or **No** if you do not want to change.

The default language is determined by the SIM card. See *Phone settings*, p.8 on how to change language, time and date.

**Tip:** You can run the start-up wizard later if you want. From standby mode, press **Menu** → **Settings** → **General** → **Start-up wizard**.

## Phone indicators

Lights on the phone will:

- Flash green when you have a new message or a missed call. After reading the new message/missed call, the flashing will stop.
- Flash red when the battery is running low and during charging.









## How to navigate the phone

### Standby (idle mode)

When the phone is ready to use, and you have not keyed in any characters, the phone is in standby.



**Tip:** You can always press  to return to standby.

### Navigation buttons

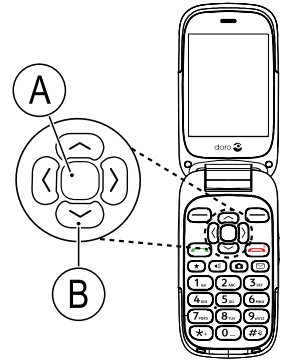
- Press (A)  to confirm.
- Alternatively press selection button **OK**.
- Press (A)  from standby to open the phone menu.
- Alternatively press left selection button  **Menu** to access the phone menu or right selection button  **Name** to access your saved contacts in the phonebook.
- Press the arrow buttons (B) ,  and ,  to scroll and to select.



### Step-by-step instructions

The arrow (→) indicates next action in step-by-step instructions. To confirm an action, press **OK**. To select an item, scroll or highlight the item using / and then press **OK**.

Example:

- Press **Menu** → **Phonebook** → **-New contact-** → **Add**.

---

To perform the example on your Doro 6520 you should do the following:

### Example 1 (use the selection buttons)

1. Press **Menu**, scroll to **Phonebook** and press **OK**.
2. Select **-New contact-** and press **Add**.

### Example 2 (use the navigation buttons)

1. Press , scroll to **Phonebook** and press .
2. Select **-New contact-** and press  to confirm.

## Enter text

### Enter text manually



#### Select character

- Press a numerical key repeatedly until the desired character is shown. Wait a few seconds before entering the next character.

#### Special characters

1. Press  for a list of special characters.
2. Select the desired character with the arrow keys and press **OK** to confirm.

#### Move the cursor within text

- Use  or  to move the cursor within the text.

#### Upper case, lower case and numerals

- Press  to choose between upper case, lower case and numerals. See *Input mode*, p.6.

#### Change writing language





1. Press and hold  for a list of available languages.
2. Select language with / and press **OK** to confirm.

#### Enter text with predictive text

In some languages you can use the Smart ABC (eZiType™) input method which uses a dictionary to suggest words.

- Press each key **once**, even if the displayed character is not the one you want. The dictionary will suggest words based on the keys you have pressed.

## Example

1. Press **3**, **7**, **3**, **3** to write the word “Fred”. Complete the word before looking at the suggestions.
2. Use ,  and ,  to view the suggested words.
3. Press **Select** and continue with the next word.  
Alternatively, press **0** to continue with the next word.
4. If none of the suggested words are correct, use manual input mode.

**Note!** See *Predictive text*, p.27 for more information.

## Input mode

Press **#** to change input mode. The icon on the top left of the display indicates the input mode.

<input checked="" type="checkbox"/> <b>Abc</b>	Sentence case with predictive text
<input checked="" type="checkbox"/> <b>ABC</b>	UPPER CASE with predictive text
<input checked="" type="checkbox"/> <b>abc</b>	lower case with predictive text
<b>Abc</b>	Sentence case
<b>ABC</b>	UPPER CASE
<b>abc</b>	lower case
<b>123</b>	Numerals

## Volume control

### During a call

- Use the side buttons **+/-** or ,  to adjust the sound volume. The volume level is indicated on the display.

If you use a hearing aid or have hearing difficulties when using the telephone in a noisy environment, you can adjust the phone's audio settings, see *Audio setup* , p.40.

## Silent

Silent is a fixed profile with Keypad tone, Message tone and Ringtone disabled, while Vibration, Tasks, Daily reminder and Alarm are unchanged.

- Press and hold shortcut button **#** to activate or deactivate silent mode.

---

## Headset

When a headset is connected, the internal microphone in the phone is automatically disconnected. If available, use the answer key on the headset to answer and end calls.



### CAUTION

Using a headset at high volume may damage your hearing. Adjust the volume level carefully when using a headset.

## Hearing aid compatible

This phone is hearing aid compatible. Hearing aid compatibility is not a guarantee that a specific hearing aid will work with a specific phone. Mobile phones contain radio transmitters that may interfere with hearing aid performance. This phone has been tested for use with hearing aids, for some of the wireless technologies that it uses, but there may be some newer wireless technologies that have not been tested yet for use with hearing aids. To ensure that a specific hearing aid works well with this phone, test them together before making a purchase.

The standard for hearing aid compatibility contains two types of ratings:

- **M:** To use your hearing aid in this mode, make sure that your hearing aid is set to "M-mode" or acoustic coupling mode, and position the phone's receiver near the hearing aid's built-in microphone. For the best results, try using the phone in different positions relative to your hearing aid—for example, placing the receiver slightly above the ear may result in better performance for hearing aids with microphones positioned behind the ear.
- **T:** To use your hearing aid in this mode, make sure that your hearing aid is set to "T-mode" or telecoil coupling mode (not all hearing aids have this mode). For the best results, try using the phone in different positions relative to your hearing aid—for example, placing the receiver slightly below or in front of the ear may result in better performance.

See also *Audio setup* , p.40 on how you can adjust the audio settings.

---

## Phone settings

### Time & date

#### Set the time and date

1. Press **Menu** → **Settings** → **General** → **Time & date**:
  - **Set time** to enter the time (HH:MM).
  - **Set date** to enter the date (DD/MM/YYYY).
2. Press **OK** to confirm.



**Tip:** You can also set the phone to automatically update the time and date according to the current time zone. In **Time & date** select **Auto time** → **On**. Automatic update of date and time does not change the time you have set for the alarm clock or the calendar. They are in local time. Updating may cause some alarms you have set to expire depending on network support and subscription.

#### Set the time and date format

1. Press **Menu** → **Settings** → **General** → **Time & date** → **Set format**:
  - **Time format** → **12 hours** or **24 hours**.
  - **Date format** and select the desired date format.
2. Press **OK** to confirm.

### Language

The default language for the phone menus, messages, etc. is determined by the SIM card. You can change this to any other language supported by the phone.

1. Press **Menu** → **Settings** → **General** → **Language**.
2. Use / to select a language.
3. Press **OK** to confirm.

### Block function

1. Press **Menu** → **Settings** → **General** → **Block function**.
2. Select each function you want to disable and press **Off**.
3. Press **Done** to confirm.

---

## PIN code options

1. Press **Menu** → **Settings** → **Security** → **SIM lock**:
  - **On** to activate the PIN code. You need to enter the PIN code every time the phone is started.
  - **Off** to deactivate the PIN code.

### IMPORTANT!

If enabling Off-mode and the SIM card is lost or stolen, it is unprotected.

- **Automatic** to start the phone without the PIN code. The phone remembers it automatically, but if the SIM card is moved to another phone (lost or stolen) the PIN code needs to be entered when the phone is started.
2. Press **OK** to confirm.

## Change PIN code

1. Press **Menu** → **Settings** → **Security** → **Passwords** → **PIN**.
2. Enter current PIN code and press **OK**.
3. Enter new PIN and press **OK**. Repeat to confirm.

## Phone lock

The phone lock protects your phone from unwanted usage. If activated, phone is locked after restart and the phone code needs to be entered to unlock.

1. Press **Menu** → **Settings** → **Security** → **Phone lock**.
2. Select **On** to enable, or **Off** to disable.
3. Press **OK** to confirm.

**Note!** You need to enter current phone code. Default phone code is **1234**.

## Whitelist



A whitelist works much like a spam filter, once activated, you can only receive incoming calls from contacts saved in the phonebook. People not stored in the phonebook gets a busy signal when trying to call you.

1. Press **Menu** → **Settings** → **Security** → **Whitelist**.
2. Select **On** to enable, or **Off** to disable.
3. Press **OK** to confirm.









## Calls

### Make a call



1. Enter the phone number including the area code. Delete with **Clear**.
2. Press  to make a call. Press **Abort** to cancel the call.
3. Press  to end the call.

**Tip:** For international calls, always use **+** before the country code for best operation. Press  twice for the international prefix **+**.

### Call from the phonebook

1. Press **Name** to open the phonebook.
2. Use / to scroll through the phonebook, or quick search by pressing the key corresponding to the first letter of the entry, see *Enter text* , p.5.
3. Press **Options**  **Call** to dial the selected entry. If needed, select the number.  
Alternatively, press  to dial.
4. Press **Abort** or  to cancel the call.

### Receive a call

1. Open the flip and press  to answer.  
Alternatively press **Silent** to switch off the ringsignal or press /close the flip to reject directly (busy signal).
2. Press  to end the call.

To answer an incoming call by opening the flip, see *Answer mode*, p.13.

**Tip:** Press and hold **+/-** to temporarily switch off the ringsignal without opening the flip.

### Call information

During a call, the outgoing or incoming phone number and the elapsed call time is displayed. If the identity of the caller is withheld, **Unknown** is displayed.

## Call options



During a call the selection buttons<sup>1</sup> (☐) give access to additional functions.

### Options (left selection button)

- **Volume** to adjust the volume.
- **Hold/Retrieve** to hold/retrieve the current call.
- **End single call** to end the current call (same as .
- **New call** to call another number (Conference).
- **Phonebook** to search the phonebook.
- **Messages** to write or read text messages.
- **Mute** to disable the microphone.

### SPK on (right selection button)

The loudspeaker allows you to speak without holding the phone close to the ear.

1. Press **SPK on** to activate. Speak clearly into the phone microphone at a maximum distance of 1 m. Use / to adjust the loudspeaker volume.
2. Press **SPK off** to return to normal mode.

**Note!** Loud background noises (music, etc.) may interfere with the sound quality.

### Speed dial

Use **A**–**B**, **0** and **2**–**9** to speed dial an entry from standby.

- Press and hold the corresponding key to speed dial.

### Add speed dial numbers

1. Press **Menu** → **Settings** → **Phonebook** → **Speed dial**.
2. Select **A** → **Add** and select an entry from the phonebook.
3. Press **OK** to confirm.
4. Repeat to add speed dial entries for buttons **B**, **0**, **2**–**9**.

---

1. Selection buttons have multiple functions. The current function is shown above the selection button on the display.

**Tip:** To edit or delete an existing entry, select it and press **Options** → **Edit** or **Delete**.







## SOS calls

As long as the phone is switched on, it is always possible to place an SOS call by entering the main local emergency number for your present location followed by .

Some networks accept calls to emergency numbers without a valid SIM card. Contact your service provider for more information.

## Call log

Received, missed and made calls are saved in a combined  call log. 20 calls of each type can be stored in the log. For multiple calls related to the same number, only the most recent call is saved.

1. Press .  
Alternatively, press **Menu** → **Call log**.
2. Use / to select:
  -  Received call
  -  Dialed call
  -  Missed call
3. Press , or **Options**:
  - **View** to show details for the selected call.
  - **Send SMS** to send a text message.
  - **Send MMS** to send a picture message.
  - **Delete** to delete the call.
  - **Delete all** to delete all calls in the call log.
  - **Save** to save the number in the phonebook → **Create new** create new contact, or **Update** update existing contact.

## Call settings

### Call time

During a call, the duration of the call is shown. You can check the duration of your calls.

1. Press **Menu** → **Settings** → **Calls** → **Call time**:

- **Last call** to show the elapsed time of the most recent call.
- **Outgoing calls** to show the elapsed time of all made calls.
- **Received calls** to show the elapsed time of all received calls.
- **Reset all** → **Yes** to reset all.

2. Press **OK** to confirm.

## Answer mode

1. Press **Menu** → **Settings** → **Calls** → **Answer mode**:

- **Open to answer** → **On** to answer incoming calls by opening the flip.
- **Any key** → **On** to be able to answer incoming calls by pressing any key (exemption .

2. Press **OK** to confirm.

## Caller ID

Display or hide your phone number on the recipient's phone when you call.

1. Press **Menu** → **Settings** → **Calls** → **Call setup** → **Caller ID**:

- **Set by network** to use default setting by the network.
- **Hide ID** to never show your number.
- **Send ID** to always show your number.

2. Press **OK** to confirm.

## Call waiting

You can handle more than one call at a time, put the current call on hold and answer the incoming call. When activated, an alert tone is heard if there is an incoming call while talking.

- During a call, press **Options** → **Answer**.

## Activate call waiting

1. Press **Menu** → **Settings** → **Calls** → **Call setup**.

2. Select **Call waiting** → **Activate**.

3. Press **OK** to confirm.

**Tip:** Repeat and select **Deactivate** to disable call waiting, or **Query status** to display if call waiting is active or not.

---

## Call divert

You can divert calls to an answering service or to another phone number. Set up which calls should be diverted. Select a condition and press **OK**, then select **Activate**, **Deactivate** or **Query status** for each.

1. Press **Menu** → **Settings** → **Calls** → **Call setup** → **Call divert**:
  - **Voice calls** to divert all voice calls.
  - **Unreachable** to divert incoming calls if the phone is turned off or out of range.
  - **No reply** to divert incoming calls if unanswered.
  - **If busy** to divert incoming calls if the line is busy.
  - **Cancel diverts** to cancel all call divert settings.
2. Press **OK** to confirm.

## Call barring

Your phone can be restricted to disallow certain types of calls.

**Note!** A password is needed to apply call barring. Contact your service provider to get the password.

1. Press **Menu** → **Settings** → **Calls** → **Call setup** → **Call barring**.
2. Select **Outgoing calls**:
  - **All calls** to answer incoming calls but not calling.
  - **Internat.calls** to block calls to international numbers.
  - **Int. except home** to block international calls except to the country associated with the SIM card.
3. Press **OK** to confirm.
4. Select **Incoming calls**:
  - **All calls** to call but not to receive incoming calls.
  - **When roaming** to block incoming calls while roaming (operating in other networks).
5. Press **OK** to confirm.
6. Select **Cancel all** to cancel all call barring (password needed). Press **OK** to confirm.

## Fixed dial (FDN)

You can limit calls to certain numbers saved on the SIM card. The list of allowed numbers is protected by your PIN2-code.

---











**Note!** The PIN2-code is needed to apply fixed dial. Contact your service provider to get the PIN2-code.

1. Press **Menu** → **Settings** → **Security** → **Fixed dial**:
  - **Mode** → **On** to enable or **Off** to disable.
  - **Fixed numbers** → **Add** and enter the first allowed number. Alternatively, select an entry and press **Options** → **Add**, **Edit** or **Delete**.
2. If needed, enter PIN2 and press **OK** to confirm.

**Note!** You can save parts of phone numbers. For example, if you save 01234, allows calls to all numbers starting with 01234. It is possible to place an SOS call by entering the main local emergency number followed by  even when fixed dial is activated. When fixed dial is activated you are not allowed to view or manage any phone numbers saved on the SIM card. You are not able to send any text messages either.







## Phonebook

### Add contact

1. Press **Menu** → **Phonebook** → **-New contact-** → **Add**.
2. Enter a  **Name** for the contact, see *Enter text* , p.5. Delete with **Clear**.
3. Use / to select  **Mobile**,  **Home** or  **Office** and enter the phone number(s) including the area code.
4. Select  **E-mail** to associate e-mail address to the contact, see *E-mail settings*, p.30.
5. Select  **Picture** → **Edit** to associate picture to the contact, see *Phonebook picture*, p.17.
  - **Take picture** to use the camera to take a picture.
  - **My pictures** to select an existing picture.
6. Select  **Ringtone** → **Edit** to associate ringtone to the contact, see *Tone setup (ringtone)*, p.40.
  - **System** to select from preinstalled files.
  - **User** to select from your downloads.
7. Press **Save**.

**Tip:** For international calls, always use + before the country code for best operation. Press  twice for the international prefix +.

## Manage phonebook contacts

1. Press **Menu**  **Phonebook**.
2. Select a contact, then press **Options**:
  - **View** to show details for the selected contact.  Phone = storage set to Phone and  SIM = storage set to SIM, see *Phonebook storage*, p.17.
  - **Edit** to edit the contact. Use / to scroll. Delete with **Clear**. Press **Save** when done.
  - **Top 10** to set the entry as one of the first 10 contacts listed in the phonebook. See *Top 10*, p.18.
  - **Call** to call the contact.
  - **Add** to add contact. See *Add contact*, p.15.
  - **Send SMS** to create text message, see *Create and send text message (SMS)*, p.22.
  - **Send MMS** to create picture message, see *Create and send picture message (MMS)*, p.23.
  - **Send e-mail** to create e-mail message, see *Create and send e-mail*, p.24.
  - **Delete** to delete the selected contact. Press **Yes** to confirm or **No** to abort.
  - **Delete all**  **From SIM/From phone** to delete all phonebook contacts from the SIM card or phone memory. Enter the phone code and press **OK** to confirm. The default phone code is **1234**.
  - **Copy all**  **From SIM** to copy all phonebook contacts from the SIM card to the phone memory, or **From phone** to copy all contacts from the phone memory to the SIM card. Press **Yes** to confirm or **No** to abort.
  - **Send vCard**:
    - **Send by SMS**, see *Create and send text message (SMS)*, p.22.
    - **Send by MMS**, see *Create and send picture message (MMS)*, p.23.
    - **Send by Bluetooth**, see *Bluetooth*<sup>®</sup>, p.35.

- **Send by e-mail**, see *Create and send e-mail*, p.24.

3. Press **OK** to confirm.

## Phonebook settings

### Owner number

The phone number assigned to your SIM card is saved as **Owner number** if this is allowed by the card.

### Add numbers

1. Press **Menu** → **Phonebook** → **Owner number** → **Empty** → **Add**.
2. Enter name and number, see *Enter text* , p.5.
3. When done, press **OK**.

### Phonebook storage

1. Press **Menu** → **Settings** → **Phonebook** → **Storage**:
  - **SIM** to save up to 3 phone numbers and one e-mail address per contact.
  - **Phone** to save 500 contacts with 3 phone numbers each **Mobile**, **Home**, **Office**. As well as one e-mail address, and **Phonebook picture** to assign images to contacts and **Ringtone** to assign specific ringtones to contacts.
2. Press **OK** to confirm.

**Note!** Number and length of the phone numbers/contacts that can be stored will vary depending on SIM card/service provider preferences.

### Phonebook picture

You can change the phonebook view mode.

1. Press **Menu** → **Settings** → **Phonebook** → **Phonebook picture**:
  - **On** to display the contact's associate picture if existing.
  - **Off** to display only the names of contacts.
2. Press **OK** to confirm.

### Voice mail

If your subscription includes an answering service, callers can leave a voice mail message when you are unable to answer a call. **Voice mail** is a network service and you may need to subscribe to it first. For more information and for the voice mail number, contact your service provider.



1. Press **Menu** → **Settings** → **Phonebook** → **Voice mail**:
2. Select **Empty** → **Add**:
  - **Phonebook** to add a contact from the Phonebook. Press **OK** to confirm.
  - **Manual** and enter name and number.
3. Press **OK** to confirm.



To edit or delete an existing entry, select it and press **Options** → **Edit** or **Delete**.

### Call voice mail

- Press and hold shortcut button **1**.

### Top 10

Set an entry as one of the first  10 contacts listed in the phonebook.



1. Press **Menu** → **Settings** → **Phonebook** → **Top 10**.
2. Select one of the empty entries and press **Add**.
3. Use / to scroll through the phonebook, or quick search by pressing the key corresponding to the first letter of the entry.
4. Press **OK** to save the selected entry, or press **Back** to discard changes.

To edit or delete an existing entry, select **Options** → **Edit** or **Delete**.

**Tip:** You can also add an  entry from the phonebook. Select the contact and press **Options** → **Top 10**.

### ICE (In Case of Emergency)

First responders can access additional information such as medical information from the victim's phone  ICE in case of emergency. In the event of a trauma, it is critical to have this information as early as possible to increase the chances of survival. All fields are optional, but the more information provided the better.

1. Press **Menu** → **Phonebook** → **ICE**.
2. Use / to scroll the list of entries.
3. Press **Edit** to add or edit information in each entry, see *Enter text* , p.5. Delete with **Clear**.

### ID

- **Name:** enter your name.
- **Birth:** enter your date of birth.
- **Height:** enter your height.
- **Weight:** enter your weight.
- **Address** enter your home address.
- **Language:** enter your preferred language.
- **Insurance:** enter your insurance provider and policy number.

#### **Contact 1:, Contact 2: and Doctor:**

- Press **Options** to **Add** or **Delete** a contact from the phonebook, or **Save** to accept the current entry.  
If possible, add your relationship to your ICE contacts in the phonebook, such as “ICE Wife Mary Smith”.

#### **Important info**

- **Condition:** enter any medical conditions or medical devices (e.g. diabetic, pacemaker).
- **Allergies:** enter any known allergies (e.g. penicillin, bee stings).
- **Blood type:** enter your blood type.
- **Vaccination:** enter any relevant vaccination.
- **Medication:** enter any medication that you are treated with.
- **Other info:** enter other information (e.g. organ donor, living will, consent to treat).

4. When done, press **Save**.

## **Assistance button**





### **CAUTION**

When an assistance call is activated the phone is pre-set to handsfree/speakerphone mode. Do not hold the device near your ear when the handsfree mode is in use, because the volume may be extremely loud.

The assistance button allows easy access to contact your predefined help numbers (Number list) should you need help. Make sure that the assistance function is activated before use, enter recipients in the numbers list and edit the text message.

## Make an assistance call

1. When help is needed, press and hold the assistance button for 3 seconds, or press it twice within 1 second.  
The assistance call begins after a delay of 5 seconds. In this time you can prevent a possible false alarm by pressing .
2. An assistance text message (SMS) is sent to all recipients.
3. The first recipient in the list is called. If the call is not answered within 25 seconds, the next number is called. Calling is repeated 3 times or until the call is answered, or until  is pressed.

**Note!** Some private security companies can accept automatic calls from their clients. Always contact the security company before using their phone number. Programming '999' into the assistance button is blocked.

**Tip:** The assistance function may be configured so that the recipient of the call must press **0** (zero) to confirm, in order to stop the alarm sequence. See *Confirm with "0"*, p.22.

### IMPORTANT!

Information to the recipient of an assistance call, when Confirm with "0" is activated.

- After receiving the assistance message, each number in the Number list is called sequentially.
- To confirm the assistance call, the recipient needs to press **0**.
  - If the recipient doesn't press **0** within 60 seconds (after answering) the call will be disconnected and the next number in the sequence will be called.
  - If the recipient presses **0** within 60 seconds, the call is confirmed and no further call attempts will be made (assistance sequence interrupted).

## Activation

Select how to activate the assistance function using the assistance button.

1. Press Menu → Settings → Assistance → Activation:

- **On Normal** to press and hold the button for approximately 3 seconds, or press it twice within 1 second.
  - **On (3)** to press the button 3 times within 1 second.
  - **Off** to disable the assistance button.
2. Press **OK** to confirm.

## Number list

Add numbers to the list that is called when the assistance button is pressed.

### IMPORTANT!

Always inform recipients in the **Number list** that they are listed as your assistance contacts.

1. Press **Menu** → **Settings** → **Assistance** → **Number list**.
2. Select **Empty** → **Add** → **Phonebook** to add a contact from the phonebook.  
Alternatively, press **Manual** to add names or numbers manually. See *Add contact*, p.15.
3. Press **OK** to confirm.
4. Repeat until you have 5 contacts (maximum).

**Tip:** To edit or delete an existing entry, select it and press **Options** → **Edit** or **Delete**.

## Activate text messages (SMS)

A text message can be sent to the contacts in the numbers list when the assistance button is pressed.

### Activation

1. Press **Menu** → **Settings** → **Assistance** → **SMS** → **Activation**:
  - **On** to send a text message before calling.
  - **Off** to call without sending a text message first.
2. Press **OK** to confirm.

### Create assistance message

1. Press **Menu** → **Settings** → **Assistance** → **SMS** → **Message**.
2. Select **Edit** and write the message, see *Enter text* , p.5.
3. Press **OK** to confirm.

**Note!** You **must** write a message if you activate the SMS function.

## Assistance settings

### Confirm with "0"

You can activate the Confirm with "0" function. This is especially recommended if there is a risk that the assistance call is answered by a voice mail or answering service. If the recipient doesn't press **0** within 60 seconds the call will be disconnected and the next number in the sequence will be called. If the recipient presses **0** within 60 seconds, the call is confirmed and no further call attempts will be made (assistance sequence interrupted).

1. Press **Menu** → **Settings** → **Assistance** → **Confirm with "0"**.
2. Select **On** to enable, or **Off** to disable.
3. Press **OK** to confirm.

### Signal type



Select the notification signal type for the assistance sequence.

1. Press **Menu** → **Settings** → **Assistance** → **Signal type**:
  - **High** to use loud signals (default).
  - **Low** to use one low signal.
  - **Silent** no sound indication, like a normal call.
2. Press **OK** to confirm.

## Messages

### Create and send text message (SMS)

**Note!** Before you can send any text messages, you need to save your message centre number. The number to your service centre is supplied by your service provider and is usually set on the SIM card. If not, you can enter the number yourself. See *SMS centre*, p.27.

1. Press shortcut button , or press **Menu** → **Messages** → **Create new** → **SMS**.
2. Write your message, see *Enter text* , p.5, then press **To**.
3. Select a recipient from **Phonebook**. Alternatively, select **Enter number** to add recipient manually and press **Done**.

- 
4. Press **Add** to add more recipients.



**Tip:** You can modify the recipients by selecting one, press **Options** → **Edit/Delete/Delete all**.

5. When done, press **Send**.

**Note!** If you choose to add multiple recipients, you will be charged for each recipient (maximum 10). For international calls, always use **+** before the country code for best operation. Press **\***  twice for the international prefix **+**.

## Create and send picture message (MMS)

A picture message can contain text and media objects such as pictures, sound recordings and video. Both you and the recipient must have subscriptions that support picture message. The settings for picture message are supplied by your service provider and can be sent to you automatically via text message. If not, see *MMS settings*, p.28 on how to set your MMS profile.

1. Press shortcut button , or press **Menu** → **Messages** → **Create new** → **MMS**.
2. Write your message, see *Enter text* , p.5.
3. Press **Options** → **Add picture**:
  - **My pictures** to select a file.
  - **Take picture** to use the camera to take a picture.

**Note!** If you add more than one picture, the following pictures are increasingly compressed by the phone (scaled down). This to allow you to send more pictures in one message. To keep best picture quality, send only one picture per message.

You can also **Add sound**, **Add video** and, **Preview MMS** using the **Options** menu.

4. Press **Options** → **Add subject** and enter your subject, then press **Done**.
  5. Press **Options** → **To** and select recipient from **Phonebook**. Alternatively, select **Enter number** to add recipient manually and press **Done**.
  6. Press **Add** to add more recipients.
-

7. Press **Send** to send.

## Create and send voice message

A voice message uses the same technology as a picture message. Both you and the recipient must have subscriptions that support picture message. The settings for picture message are supplied by your service provider and can be sent to you automatically via text message. If not, see *MMS settings*, p.28 on how to set your MMS profile.



1. Press the shortcut button , or press **Menu** → **Messages**.
2. Select **Create new** → **Voice message**.
3. Recording starts immediately. Press **Stop** when done and press **Yes** to save.
4. Select recipient from **Phonebook**. Alternatively, select **Enter number** to add recipient manually and press **Done**.
5. Press **Add** to add more recipients
6. Press **Send** to send.

## Create and send e-mail

### IMPORTANT!

Using data services can be costly. We recommend that you check your data rates with your service provider.

You can send or view e-mail messages using your personal or company e-mail account. See *E-mail settings*, p.30 on how to setup your e-mail.

1. Press the shortcut button , or press **Menu** → **Messages** → **Create new** → **E-mail**.
2. Write your message, see *Enter text* , p.5,
3. Select **Options**.
4. Select **To** and select recipient from **Phonebook**. Alternatively, select **Enter recipient** to add recipient manually and press **Done**.
5. Press **Add** to add more recipients.
6. Press **Back**.
7. From **Options** → **Add subject**.

---

## 8. From **Options** → **Add picture**:



- **My pictures** to select a file.
- **Take picture** to use the camera to take a picture.

You can also **Add sound** and **Add video** using the **Options** menu.

## 9. Press **Send** to send.

### Switch between accounts

If you create more than two e-mail accounts, you can switch between them.

1. Press **Menu** → **Messages** → **E-mail** → **Change account** → **Accounts**.
2. Use / to select account.

### Download e-mail

- Press **Menu** → **Messages** → **E-mail** → **Inbox**.

**Note!** After configuring your account, you can view previously retrieved e-mail offline or connect to the e-mail server to view new messages. After you retrieve e-mail messages, you can view them offline.

### Signing in on Gmail / Yahoo

E-mail accounts, like Gmail and Yahoo require you to change an account setting before you are able to access e-mails on your new Doro phone. To avoid problems signing in, you may need to log-into your Gmail / Yahoo account. Please use the following process to activate the use of your account on your Doro phone or you may receive a 'pop up' message that the 'authentication process has failed'.

### Account settings

1. Use a computer web browser to log in to your Gmail/Yahoo account.
2. Click your name (top right corner) → **My Account** → (Under the security section click) **Connected apps & sites/Account security** → **Allow less secure apps** → Set the switch to **ON**.
3. Try to log in with your device again



### Gmail still not working?

1. Use a computer web browser to log in to your Gmail account.



- 
2. Use the shortcut link: <https://accounts.google.com/b/0/DisplayUnlockCaptcha>
  3. Click **Continue**.
  4. Try to log in with your device again.

## Inbox, Outbox and Sent

1. Press shortcut button .  
Alternatively press **Menu** → **Messages**.
  2. Select **Inbox**, **Outbox** or **Sent**.
  3. Select a message and press **Read**. Use / to scroll up/down.
  4. Press **Options**:
    - **View** (MMS only) to view the message.
    - **Call** to call the contact.
    - **Resend** to send again to the same recipient.
    - **Reply** to write your reply, then press **Send**. The message is sent immediately.
    - **Delete** to delete. Press **Yes** to delete or **No** to return.
    - **Download/Cancel download**. If the message is not downloaded yet, press **Download**.
    - **Edit** to edit the message, then press **Send**.
    - **Forward** to forward the message. Edit the message (if desired), then press **Send**.
    - **Use address** to display e-mail addresses contained in the message.
      - **Options** → **Save** → **Create new** or **Update**.
      - **Options** → **Send mail** to write a new e-mail.
    - **Use number** to display all phone numbers contained in the message as well as the sender's number.
      - **Call** to call the selected number.
      - **Save** to save the number in the phonebook.
      - **Send SMS** to write a new text message.
      - **Send MMS** to write a new picture message.
    - **Save objects** (MMS only) to save text and media objects such as pictures, sound recordings and video.
    - **Details** (MMS only) to view details of the message.
-



5. Press **OK** to confirm.

## Message settings

### Predictive text

1. Press **Menu** → **Settings** → **Messages** → **Predictive text**.
2. Select **On** (default) to enable, or **Off** to disable.
3. Press **OK** to confirm.

### Writing language

1. Press **Menu** → **Settings** → **Messages** → **Writing language**.
2. Use / to select a language.
3. Press **OK** to confirm.

### Write speed

You can change the speed at which keypad characters repeat before the cursor moves on to the next character.

1. Press **Menu** → **Settings** → **Messages**.
2. Select **Write speed** → **Slow**, **Normal** or **Fast**.
3. Press **OK** to confirm.

## SMS settings

- Press **Menu** → **Settings** → **Messages** → **SMS settings**.

### Memory status

1. From **SMS settings**, select **Memory status** to display the memory space used on the SIM card and in the phone memory. Phone memory can store up to 450 messages.
2. Press **Back** to return.

### Storage

1. From **SMS settings**, select **Storage**:
  - **SIM** (default) to store messages on the SIM card.
  - **Phone** to store messages in the phone memory.
2. Press **OK** to confirm.

### SMS centre

1. From **SMS settings**, select **SMS centre** → **Edit**.
2. Enter the service centre number. Press **Clear** to delete.

3. Press **OK** to confirm.

### Cell broadcast

You can receive messages on various topics from your service provider, such as weather or traffic conditions in a particular region. For available channels and relevant channel settings, contact your service provider. Cell broadcast messages cannot be received when the device is roaming.

1. From **SMS settings**, select **Cell broadcast**:
  - **Activation** to turn information **On** or **Off**.
  - **Read messages** to read the message.
  - **Languages** to select language **On** or **Off**.
  - **Channel settings** to select from which channels to receive or subscribe messages. Use the options **Subscribe**, **Cancel subscription**, **Add**, **Edit** and **Delete** to define your channels.
2. Press **OK** to confirm.

### MMS settings

- Press **Menu** → **Settings** → **Messages** → **MMS settings**.

### Memory status

1. From **MMS settings**, select **Memory status** to display the memory space used on the memory card (if inserted) and in the phone memory. Phone memory can store up to 8 MB.
2. Press **Back** to return.

### Storage

Picture messages are saved by default in the phone memory. When the memory becomes full you will need to either delete a picture message (see *Inbox, Outbox and Sent*, p.26) or select to save your picture messages to the memory card. When the memory is full you will see a message when you try to send or receive a picture message.

**Note!** Make sure to insert a compatible memory card before saving to it (see *Insert SIM card, memory card and the battery*, p.1). The storage menu only appears if you have inserted a card.

1. From **MMS settings** select **Storage**:
  - **Phone** to store in the phone memory.

- 
- **Memory card** to store picture messages to the memory card.
2. Press **OK** to confirm.

## MMS profile

These settings are needed to use the picture messages function. The settings for picture messages is supplied by your service provider and can be sent to you automatically.

1. From **MMS settings**, select **MMS profile**.
2. Select your service provider and press **Options** → **Activate**.

## Add new MMS profile

Follow the steps below if your service provider is not in the list. Contact your service provider for correct settings.

1. From **MMS profile**, select **Add**:
  - **Account name** to add account name.
  - **APN** to add APN (Access Point Name).
  - **User name** to add user name.
  - **Password** to add password.
  - **Homepage** to add homepage.
  - **Connection type** use the side buttons **+/-** to select connection enter **HTTP** or **WAP**.
  - **Proxy address** to add proxy address.
  - **Proxy port** to add proxy port.
  - **User name** to add proxy user name.
  - **Password** to add proxy password.
2. Press **OK** to confirm.
3. Press **Yes** to save or **No** to exit without saving.
4. Select your new profile and press **Options** → **Activate**.
5. Press **OK** to confirm.

To edit or delete an existing entry, select it and press **Options** → **Edit** or **Delete**.

---

**Note!** Some service providers require you to send a picture message before you will be able to receive one. Send a picture message with text only to activate the service. Some service providers require that you contact them before enabling picture message for your account. Contact your service provider's Customer Service. Press  during set up to exit without saving.

## E-mail settings

Enables you to review and create e-mails using your personal or company e-mail account. In order to utilize the e-mail service on your Doro 6520 you need to have an already configured e-mail account such as Google Mail, Yahoo or Hotmail.

**Note!** You can add up to 10 different e-mail accounts.

- Press **Menu** → **Settings** → **Messages** → **E-mail**:

The first time you configure an account you are prompted **Start to create account?**. Press **Yes**.

### Set up general e-mail accounts

For general e-mail accounts such as (Google Mail, Yahoo or Hotmail).

1. From **E-mail** → **Select**:
  - **Gmail**
  - **Hotmail**
  - **Yahoo**
2. Enter your **E-mail address** and your **Password**.
3. Press **OK** to confirm.

### Set up other accounts

Follow the steps below if your service provider is not in the list. Contact your service provider for correct settings.

1. From **E-mail** → **Select**:
2. Select **Other e-mail accounts**.
  - Enter **E-mail address**.
  - Select **POP3** or **IMAP4**.
  - Enter **Incoming server**.
  - Enter **Outgoing server**.

- Enter **User name**.
  - Enter **Password**.
  - Enter **Account name**.
3. Select **Check interval**.

### IMPORTANT!

Using data services can be costly. We recommend that you check your data rates with your service provider before selecting any of below intervals.

- **Off** is default.
  - **5 min**
  - **30 min**
  - **1 hour**
  - **2 hours**
4. Press **OK** to confirm.

To edit or delete an existing entry, select it and press **Options** → **Edit/Delete**. Select **E-mail setup wizard** to configure new accounts.

## Vibration

The text message vibration alert is several short vibrations.

1. Press **Menu** → **Settings** → **Messages** → **Vibration**.
2. Select **Messages**:
  - **Short** (4 seconds)
  - **Long** (12 seconds)
3. Press **OK** to confirm.

**Note!** If **Alert type** is set to **Ring only** the phone will not vibrate.

## Reminder

The reminder alerts you once if you haven't checked your messages or listened to your voice mail within 10 minutes from receipt. When notified, press  to end the notification and no more reminder is heard.

1. Press **Menu** → **Settings** → **Messages** → **Reminder**.
2. Select **On** to enable, or **Off** to disable.
3. Press **OK** to confirm.

## Delivery report

You can select if you want the phone to notify you when your text message has reached the recipient.

**Note!** Contact your service provider for detailed subscription costs before activating.

1. Press **Menu** → **Settings** → **Messages** → **Delivery report**:
2. Select **On** to enable, or **Off** to disable.
3. Press **OK** to confirm.



## Camera

You can take photos, record videos and view your photos and videos using the  Camera menu.



## Camera

### Camera (take photos)

To get sharp photos, wipe the lens clean with a dry cloth.

1. Press shortcut button .  
Alternatively press **Menu** → **Camera** → **Camera**.
2. Press  to take photo.
3. Press **Options**:
  - **Send** → **Send by MMS**, see *Create and send picture message (MMS)*, p.23.
  - **Send** → **Send by Bluetooth**, see *Bluetooth*<sup>®</sup>, p.35.
  - **Send** → **Send by e-mail**, see *Create and send e-mail*, p.24.
  - **Delete** to delete. Press **Yes** to confirm or **No** to return.
  - **Use** → **Wallpaper** to save as display background.
  - **Use** → **Phonebook picture** to save as phonebook contact.
4. Press **Back** to take a new photo.  
If you do not make any selection the picture is saved.

### Camera adjustments



- Use / to zoom in and out.
- Use the side buttons **+/-** to adjust EV/Light sensitivity.

**Note!** Zoom may reduce picture quality.



For more camera settings, see *Camera settings*, p.34.

## Video camera

To get sharp videos, wipe the lens clean with a dry cloth.

1. Press **Menu** → **Camera** → **Video camera**.
2. Press  to start recording.
3. Press  to stop recording. Select **Yes** to save.
4. Press **Options**:
  - **Play**
  - **Send** → **Send by MMS**, see *Create and send picture message (MMS)*, p.23.
  - **Send** → **Send by e-mail**, see *Create and send e-mail*, p.24.
  - **Send** → **Send by Bluetooth**, see *Bluetooth*<sup>®</sup>, p.35.
  - **Delete** to delete. Press **Yes** to confirm or **No** to return.
5. Press **Back** to return.

## Video camera adjustments







- Use / to zoom in and out.
- Use the side buttons **+/-** to adjust EV/Light sensitivity.
- Use **Lamp** to switch the lamp on or off.

**Note!** Zoom may reduce video quality.

For more video camera settings, see *Camera settings*, p.34.

## Picture gallery and Video gallery

View your saved pictures  or videos .

1. Press **Menu** → **Camera** → **Picture gallery** or **Video gallery**.
2. Use / or / to select a picture or video.
3. Press **Options**:
  - **View** for single view. Press **Back** to return.  
Use / to play and stop the video (video only).
  - **Send** → **Send by MMS** to send as picture message. See *Create and send picture message (MMS)*, p.23.



- **Send** → **Send by Bluetooth** to send to a Bluetooth device, see *Bluetooth*<sup>®</sup>, p.35.
- **Send** → **Send by e-mail**, see *Create and send e-mail*, p.24.
- **Delete** to delete. Press **Yes** to confirm or **No** to return.
- **Use** (picture only) → **Wallpaper** to save as display background.
- **Use** (picture only) → **Phonebook picture** to save as phonebook contact.
- **Details** to view detailed information about the file, e.g. date, size, copyright.
- **Rename** to rename picture.
- **Browse style** (picture only) to change view. Select **Large**, **List** or **Medium**.

4. Press **OK** to confirm.

## Camera settings

1. Press **Menu** → **Settings** → **Camera**:

- **EV information**: EV/Light sensitivity can be adjusted by pushing volume keys up and down when in camera mode.
- **Browse style** to change view. Select **Large**, **List** or **Medium**.
- **Sort by** to sort pictures and videos by **Name** or **Time**.
- **Storage** to save pictures and videos on **Phone** or **Memory card**.

**Note!** This option is only available when a compatible external memory is inserted in the device.

- **Delete all** to delete all saved pictures and videos.
- **Image size** to set as **Small** (lowest quality), **1 MP** or **2 MP** (highest quality).
- **Video camera** → **Quality** to set as **High** or **Low**.
- **Video camera** → **Record time** to set as **No limit** or **1 min**.
- **Shutter sound** → **Off**, **Low** or **High**.

2. Press **OK** to confirm.

**Note!** With higher quality, less pictures or videos can be stored in the internal memory.

If you insert a compatible external memory (micro SD) card into your Doro 6520, you can change the default storage location, see *Storage*, p.28. This allows you to save more files on your device, like pictures and videos.

## Connectivity

### Bluetooth®

#### IMPORTANT!

When you are not using Bluetooth connectivity, select **Function on/off** → **Off** or select **Visibility** → **Off**. Do not pair with an unknown device.

#### Activate Bluetooth

1. Press **Menu** → **Settings** → **Bluetooth** → **Function on/off**.
2. Select **On** to enable, or **Off** to disable.
3. Press **OK** to confirm.

#### Bluetooth settings

##### Visibility

1. Press **Menu** → **Settings** → **Bluetooth** → **Visibility**.
2. Select **On** to make your device visible to other devices, or **Off** to be invisible.
3. Press **OK** to confirm.

**Note!** To prevent other devices from finding your device, select **Off**. Even if you select **Off**, paired devices can still detect your device.

##### Device name

1. Press **Menu** → **Settings** → **Bluetooth** → **Device name**.
2. Enter the name your Doro 6520 should appear with for other Bluetooth devices.
3. Press **Done** to confirm.

##### Search device

Search for available Bluetooth audio devices.

1. Press **Menu** → **Settings** → **Bluetooth** → **Search device**.
2. Select a device from the list and press **Bond** to connect. If Bluetooth is not enabled, press **Yes** to activate.
3. When connecting to another Bluetooth device you need a shared password. Enter the password and press **OK**.

---

## My devices

Add new devices or view saved.

1. Press **Menu** → **Settings** → **Bluetooth** → **My devices**.
2. Select a device from the list and press **Options**:
  - **Connect/Disconnect** to connect/disconnect with the selected device. This may require a profile, usually a headset.
  - **Rename** to change the name of the device.
  - **Delete** to delete the device from the list.
  - **Delete all** to delete all devices from the list.
  - **Security** to select an option.

## Audio path

1. Press **Menu** → **Settings** → **Bluetooth** → **Audio path**:
  - **Phone** to answer incoming calls with the phone.
  - **Forward BT** to forward incoming calls to the Bluetooth device.
2. Press **OK** to confirm.



## Security

1. Press **Menu** → **Settings** → **Bluetooth** → **Security**:
  - **Normal** (All paired devices are allowed full access automatically.)
  - **High** (Confirmation may be needed for full access for paired devices.)
  - **Information**
2. Press **OK** to confirm.

## Internet profile

The Internet settings are used by services that communicates using Internet. The Internet settings for most major service providers are already inserted from start. Another way is to ask your service provider to send the settings directly to your phone.

Follow the steps below if your service provider profile is not in the list. Contact your service provider for correct settings.

1. Press **Menu** → **Settings** → **Connectivity** → **Internet profile**.
  2. Use / to select a profile.
  3. Press **Options** → **Edit** to enter settings for your service provider:
-

- **Account name** to enter the account name.
  - **APN** to enter the APN address.
  - **User name** to enter user name.
  - **Password** to enter password.
  - **Homepage** to enter homepage.
  - **Connection type** select **HTTP/WAP**.
  - **Proxy address** to enter proxy address.
  - **Proxy port** to enter proxy port.
  - **User name** to enter user name.
  - **Password** to enter password.
4. Press **OK**, and press **Yes** to save or **No** to return.
  5. Select your new profile and press **Options** → **Activate**.
- You can also activate/modify a profile by selecting one and press **Options** → **Activate/Edit/Delete**.

## Mobile data, data counter and data roaming

### IMPORTANT!

Using data services can be costly. We recommend that you check your data rates with your service provider.

### Function on or off

Restricts features like internet browser, Facebook, Connect & Care, Weather, My Doro Manager®, MMS and e-mail. Select **Off** to avoid data charges.

1. Press **Menu** → **Settings** → **Connectivity** → **Mobile data** → **Function on/off**.
2. Select **On** to enable, or **Off** to disable.
3. Press **OK** to confirm.

### Data counter

The data counter gathers traffic information from internet browser, Weather, My Doro Manager®, MMS and e-mail.

1. Press **Menu** → **Settings** → **Connectivity** → **Mobile data** → **Data counter**.
  - **Sent**.

- **Received.**
- **Reset all.**

## Data roaming

Your phone automatically selects your (service providers) home network if within range. If not within range, you can use another network, provided your network operator has an agreement that allows you to do so. This is called roaming. Contact your service provider for more information.

1. Press **Menu** → **Settings** → **Connectivity** → **Mobile data** → **Data roaming**.
2. Select **On** to enable, or **Off** to disable.
3. Press **OK** to confirm.

### IMPORTANT!

Using data services while roaming can be costly. Contact your service provider for data roaming rates before you use data roaming.

## Network setup

1. Press **Menu** → **Settings** → **General** → **Network setup**:

### Select network

- **New search** to perform new search if connection is lost.
- **Select network** to view available network, a list of available network operators is displayed (after a short delay). Select desired operator.
- **Network mode** to select another network. Select **Automatic** to select network automatically or **Manual** to select network manually.

### Service selection

- **GSM** service only.
- **3G** service only.
- **Automatic**: switch between **GSM** and **3G** for best service.

### IMPORTANT!

If you set your phone to use GSM only or 3G only, you will not be able to make any calls, including emergency calls, or use other features requiring a network connection, if the selected network is unavailable.

---

## Network information

- View your current network settings.

## Services

This menu may contain pre-programmed services from your network provider depending on network support and subscription.

- Press **Menu** → **Settings** → **General** → **Services**.

## Connect the phone to a computer

Connect the phone to a computer and start transferring pictures, music and other file types. All you have to do is connect a USB cable between the phone and computer. From your computer's file explorer, you can drag and drop content between your phone and the computer.

**Note!** You might not be able to transfer some copyright protected material.

## Drag and drop content between phone and a computer

1. Connect your phone to a computer using a USB cable.
2. Wait until the phone or memory card appears as external disks in the file explorer.
3. Drag and drop selected files between the phone and the computer.

**Note!** You can transfer files using a USB cable on most devices and operating systems supporting a USB Mass Storage interface.

## Disconnect the USB cable safely

1. Make sure to enable the hardware to be safely removed.
2. Disconnect the USB cable.

**Note!** Computer instructions may vary depending on your operating system. See the documentation of your computer's operating system for more information.

## Sound & Display

**Note! Silent** needs to be set to **Off** to access Tone setup, Volume, Alert type and Extra tone.

## Audio setup



If you use a hearing aid or have hearing difficulties when using the device in a noisy environment, you can adjust the audio settings.

1. Press **Menu** → **Settings** → **Sound** → **Audio setup**:
  - **Normal** for normal hearing in normal conditions.
  - **Medium** for mild hearing impairment or use in a noisy environment.
  - **High** for moderate hearing impairment or use in a very noisy environment.
  - **HAC mode** for use with hearing aid.
2. Press **OK** to confirm.

**Note!** Try different settings to find the one that suits your hearing the best.



## Tone setup (ringtone)

Select a ringtone with the best tone curve adjustments and frequencies to best fit your needs.

1. Press **Menu** → **Settings** → **Sound** → **Tone setup** → **Ringtone** → **Ringtone**:
  - **System** to select from preinstalled files.
  - **User** to select from your downloads.
2. Use / to select one of the available melodies, the melody will be played.
3. Press **OK** to confirm or **Back** to discard changes.

**Tip:** Set up the **Alarm**, **Message tone**, **Keypad tone**, **E-mail tone**, **Closing tone**, **Opening tone**, **Power on** and **Power off** in the same way.

## Ringtone volume

1. Press **Menu** → **Settings** → **Sound** → **Volume**.
2. Use / to change the ringtone volume.
3. Press **OK** to confirm.

## Silent

1. Press **Menu** → **Settings** → **Sound** → **Silent**.

2. Select **On** to enable, or **Off** to disable.
3. Press **OK** to confirm.

**Tip:** From standby mode, press and hold shortcut button **#** to activate or deactivate silent mode.

## Alert type

Select to use ringtone and/or vibration for incoming calls.

1. Press **Menu** → **Settings** → **Sound** → **Alert type**:
  - **Ring only** for ringtone only.
  - **Vib. only** for vibration only.
  - **Vib. and ring** for vibration and ringtone.
  - **Vib. then ring** to start with vibration and adds ringtone after a short while.
  - **Silent** for no sound or vibration, the display light is lit.
2. Press **OK** to confirm.

## Extra tone

You can select to enable warning and error tones to alert you of low battery power, phone and SIM card errors, etc.



1. Press **Menu** → **Settings** → **Sound**.
2. Select **Extra tone** → **Warning** or **Error**.
3. Select **On** to enable, or **Off** to disable.
4. Press **Done** to save.

## Main menu

You can select different styles for the main menu.

1. Press **Menu** → **Settings** → **Display** → **Main menu**:
2. Select **Grid** or **List**.
3. Press **OK** to confirm.

## Wallpaper

1. Press **Menu** → **Settings** → **Display** → **Wallpaper**.
2. Use / to display available wallpapers.
3. Press **OK** to confirm.



## Text size

You can adjust the text size for the menu and messages.

1. Press **Menu** → **Settings** → **Display**.
2. Select **Text size** → **Normal** or **Large**.
3. Press **OK** to confirm.



## Idle display

In standby mode the display can show clock only, clock and the service provider, or all information.

1. Press **Menu** → **Settings** → **Display**.
2. Select **Idle display** → **Clock only**, **Clock & Operator** or **All info**.
3. Press **OK** to confirm.

## Themes

You can select different themes to adjust the phone's texts and background.

1. Press **Menu** → **Settings** → **Display** → **Themes**.
2. Use / to select a theme.
3. Press **OK** to confirm.

## LCD backlight

Select the delay time for the display backlight.

1. Press **Menu** → **Settings** → **Display**.
2. Select **LCD backlight** → **15 sec.**, **30 sec.** or **1 min.**
3. Press **OK** to confirm.

## Brightness

You can adjust the brightness of the display.



1. Press **Menu** → **Settings** → **Display**.
2. Select **Brightness** → **Level 1**, **Level 2** or **Level 3**.
3. Press **OK** to confirm.

## My Doro Manager®

Create an Doro Experience® account to get the most out of your phone. Access the phone using any web browser, [www.doro.com](http://www.doro.com). Easily view and share your photos or videos.

**Note!** You need to have Internet access to use most of the features in My Doro Manager®. Depending on how you use your phone, it can use up a lot of Internet bandwidth really quickly, and it can be costly. Before you use your phone, we strongly recommend that you contact your service provider about data rates.

### Create account

1. Press **Menu** → **Settings** → **My Doro Manager** → **Create account**.
2. Your username is automatically set to your phone number/owner number.  
The owner number is supplied by your service provider and is usually set on the SIM card. If not, you can enter the number yourself.
3. Enter password and press /.
4. Re-enter the password in the field below and press **OK**.

**Note!** The username may contain letters (a-z) and numbers (0-9), but (+) is not allowed.

Keep the owner number in a safe place, since it will be needed if you need to reset.

### Log in/Log out

1. Press **Menu** → **Settings** → **My Doro Manager** → **Log in**.
2. Enter your phone number as user name.
3. Enter your password and press **Log in**.

### Options

You can select to synchronise your phone with My Doro Manager®.

1. Press **Menu** → **Settings** → **My Doro Manager** → **Options**:
  - **Minimal synchronisation** to synchronise your contacts, calendar and phone settings.
  - **Full synchronisation** to synchronise the same content as above and photos.

- **Information** to view more information.
2. Press **OK** to confirm.

## Sync. intervals

You can select different synchronisation intervals.

1. Press **Menu** → **Settings** → **My Doro Manager** → **Sync. intervals**:
  - **Manual** to synchronise manually. No automatic synchronising.
  - **Every 15 minutes** to synchronise automatically every 15 minutes.
  - **Hourly** to synchronise automatically every hour.
  - **Daily** to synchronise automatically every day.
2. Press **OK** to confirm.

**Tip:** You can also synchronise manually by pressing **Synchronise now**.



## Account details

**Tip:** If you misplace or forget your account details such as user name and you password you can always follow these instructions to retrieve it.

1. Press **Menu** → **Settings** → **My Doro Manager**.
2. Select **Account** to view your account information details.  
Enter the phone code and press **OK** to confirm. The default phone code is **1234**.
3. Press **Back** to return.

## File manager

Manage the contents and properties of files. You can open, delete, move, copy and rename files.

1. Press **Menu** → **Settings** → **File manager**.
2. Select **Phone/Memory card** → **Open**.
3. Select a folder, eg **Photos** and press **Open**.
4. Select a file and press **Options**:
  - **Play** (audio/video/music), press  to **Play** or  to **Stop**.
  - **View** (photos/images) for single view.
  - **Send** → **Send by MMS** to send as picture message (*Create and send picture message (MMS), p.23*)/**Send by Bluetooth** to

send to a Bluetooth device (*Bluetooth*<sup>®</sup>, p.35)/**Send by e-mail** (*Create and send e-mail*, p.24).

- **Details** to view detailed information about the file, e.g. date, size, copyright protection.
- **Use** → **Wallpaper** to save as display background/**Phonebook picture** to send to a phonebook contact.
- **Rename** to rename the file.
- **Delete** to delete the file.
- **Delete all** to delete all files in selected folder.
- **Sort by** → **Name/Time**.
- **Copy/Move** → **Phone/Memory card** → **Options** → **Open**. Select a folder, eg **Photos** and press **Options** → **Paste**.

5. Press **OK** to confirm.

Supported formats:

- Picture format: BMP/GIF/JPG/PNG. Photos taken with the built in camera are saved as JPG.
- Audio format: WAV/AMR/MIDI/MP3/AAC/AAC+. Recordings made with the built in sound recorder are saved as AMR.
- Video format: AVI/MP4/3GPP.

## Internet

### IMPORTANT!

This service requires an Internet connection. Using data services can be costly. We recommend that you check your data rates with your service provider.

## Use the web browser

1. Press **Menu** → **Browser**.
2. Press **Accept** to accept the End User License for using the Opera™ Mobile browser. If not, press **Exit**.

## Navigate the web browser

- Use the navigation buttons to navigate the browser. The blue frame shows the selected area. Press  to select.

## Enter website address (URL)

- Select **www.** and press  to select **Edit**. Enter a website address (URL) and press **Go**.

## Search

- Press  to select **g**, located to the right of the screen, to search the web. Enter your search and press **Search**.

## Options menu

- Press **Menu** to access:

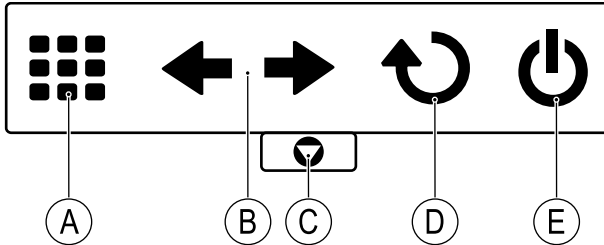

- **A** to close the current tab, if multiple tabs are used.
- **B** to go to previous or next website.
- **C** to access **Bookmarks, History, Saved Pages, Downloads, Settings, Find in Page, Homepage** and **Help**.
- **D** to refresh current website.
- **E** to exit the web browser. Press **Yes** to confirm.
- **+** located at the top right corner, to open new tab. Use the navigation buttons to switch between tabs.

## Add browser speed dials

1. Use the navigation buttons to select **+** and press **Add**.
2. Press **Edit** to enter a web address or use the navigation buttons to scroll the list of visited pages and select **Done**.

**Tip:** Select the browser speed dial and press **Open** to view.

## Use the Facebook application

1. Press **Menu** → **Internet**.
2. Press **Facebook**. Press **OK** to accept the data charges, or press **Cancel**.

## Log in

To use this app you must have a Facebook account, you can create one using the link **Create New Account** on the login screen.

**Note!** The fields are case sensitive.

1. Once you have an account, select to enter your **Email** or your **Mobile Number** and press .
2. Select **Password** and press  to enter your password.
3. Select **Log in** and press .

## Log out

1. Press **Menu** and select **Settings**.
2. Scroll to **Log out** and press . Confirm with **Yes**.

## Language

- Use  to scroll down to change the language of the Facebook app. Press  to select.

## More



The  More menu contains:

	FM radio		Games
	Calculator		Status

## FM radio

The  **FM radio** has a frequency range from 87.5 to 108.0 MHz. To listen to the radio you need to connect a compatible headset that works as antenna.



## Turning the radio on

1. Connect a headset to the headset socket .
2. Press **Menu** → **FM radio**. The radio is turned on. The tuned frequency is displayed.
3. Select channel using  or .

**Tip:** Press  to return to standby mode. The radio will continue to play.

---

## Volume

1. Press **Menu** → **FM radio** → **Options** → **Volume**.
2. Use  or  to adjust the volume.
3. Press **OK** to confirm.

## Save frequency



1. Press **Menu** → **FM radio** → **Options** → **Save frequency**.
2. Enter a name for the new channel, see *Enter text* , p.5.
3. When done, press **OK**.

## Switch off

- Press **Menu** → **FM radio** → **Options** → **Switch off**.

**Tip:** Disconnecting the headset will also turn off the radio.





## Loudspeaker

1. Press **Menu** → **FM radio** → **Options** → **Loudspeaker** → **On**.
2. Select **On**.
3. Use / to adjust the sound volume.
4. To turn off, select **Off**.

## Channel list (editing the channel list)

1. Press **Menu** **FM radio** → **Options** → **Channel list**.
2. Select the channel you wish to edit and press **Options**:
  - **Play** to play the selected channel.
  - **Delete** to delete the channel. Press **Yes** to confirm or **No** to return to the channel list.
  - **Edit** to edit the channel name, then press  to edit the frequency, use **#** to enter the decimal point. When done, press **Save**.
3. Press **Yes** to confirm.

## Manual input (change the search mode)

1. Press **Menu** → **FM radio** → **Options** → **Manual input**:
  - **Fine tune** to tune manually with  or .
  - **Auto search** to use automatic station search with  or .
2. Press **OK** to confirm.

---

**Note!** This will overwrite all previously saved channels.

### Auto save

1. Press **Menu** → **FM radio** → **Options**.
2. Select **Auto save** to automatically install available radio stations in channels **1-9**.
3. Press **OK** to confirm.

**Note!** This will overwrite all previously saved channels.

### Calculator

The  **Calculator** can perform basic mathematical operations.

1. Press **Menu** → **Calculator**.
2. Enter the first number. Use **#** to enter decimal points.
3. Use the arrow buttons to select an operation (+, -, x, ÷) and press **OK**.
4. Enter the next number and press **OK**.
5. Repeat steps 2-4 as necessary.  
Select = and press **OK** to calculate the result.

### Games



The  **Games** menu contains 2 games.

1. Press **Menu** → **More** → **Games** →
  - **Continue** to continue game.
  - **Restart level** to restart game at the same level as before.
  - **Start game** to start a new game.
  - **Game level** to select difficulty level.
  - **Best grades** to view your best results. Press **Back** to return or **Reset** to reset the scores.
  - **Help** to view instructions for the game. Press **Back** to return.
  - **Settings** → **Sound effect** to enable or disable by using the side buttons +/- to select **On** or **Off**.
  - **Settings** → **Volume** to adjust the sound volume using the side buttons +/-.
2. Press **OK** to confirm.







## Status

Scroll through the  **Status** list to get further information about the icons shown on top of your display. Icons shown on the display varies depending on your phone status.

1. Press **Menu** → **More** → **Status**.
2. Use  or  to scroll the list.
3. Press **Back** to return to standby mode.

## Organiser

The  Organizer menu contains:

	Alarm		Daily reminder
	Calendar		Notes

## Alarm

1. Press **Menu** → **Organiser** → **Alarm** → **On**.
2. Enter the alarm time using the keypad.
  - For a single occurrence, select **Single**.
  - For a repeated alarm, select **Repeated**. Scroll through the list of days and press **On** to enable or **Off** to disable the alarm for each day.
3. Press **Save** to confirm.

### Snooze or turn off

- When the alarm goes off a signal will sound. Press **Stop** to turn off the alarm or press **Snooze** to repeat the alarm after 9 minutes.



**Note!** The alarm will work even when the phone is switched off. Do not press **Yes** to power on if wireless phone use is prohibited or when it may cause interference or danger.

**Tip:** To edit an alarm, press **Edit** or **Off** to stop the alarm.

## Calendar

### Add task

1. Press **Menu** → **Organiser** → **Calendar** → **Options** → **Add task**.

2. Enter date, then press .
3. Enter time, then press .
4. Enter subject, see *Enter text* , p.5.
5. When done, press **OK**.

### Options



1. Press **Menu** → **Organiser** → **Calendar** → **Options**:
  - Select **View** to show tasks for the selected date.
  - Select **Jump to date** and enter the date.
2. Press **OK** to confirm.

### View all

1. Press **Menu** → **Organiser** → **Calendar**.
2. Select a task and press **Options** → **View all**.
3. Press **Options** → **Edit**, **Delete** or **Delete all**.
4. Press **OK** to confirm.

**Note!** The calendar reminders will work even when the phone is powered off. Do not power on your phone if wireless phone use is prohibited or when it may cause interference or danger.

### Daily reminder

1. Press **Menu** → **Organiser** → **Daily reminder** → **Add**.
2. Enter time, then press .
3. Enter subject, see *Enter text* , p.5
4. Press **OK** to confirm.

### Snooze or stop

When the alarm sounds:

- Select **Stop** to stop.
- Select **Snooze** to repeat after 9 minutes.

**Note!** The reminder will work even when the phone is powered off. Do not power on your phone if wireless phone use is prohibited or when it may cause interference or danger.

**Tip:** For more options select an existing entry, and press **Options** → **Skip reminder, Add, Edit, Delete or Delete all.**

## Notes

1. Press **Menu** → **Organiser** → **Notes** → **Add.**
2. Enter your note using the keypad, see *Enter text* , p.5.
3. Press **OK** to confirm.

**Tip:** For more options select an existing entry, and press **Options** → **View, Edit, Delete or Delete all.**

## Weather

### IMPORTANT!



Using data services can be costly. We recommend that you check your data rates with your service provider.

View the  **Weather** for your chosen city.

1. Press **Menu** → **Weather.**
2. Press **Back** to return to standby mode.

**Note!** In order to see the weather, you must first select a city.





### Weather settings

















1. Press **Menu** → **Settings** → **Weather.**
2. Select **City** and enter the name of the city.
3. Use  or  to select the city in the list.
4. Select **Wallpaper** and select **On** (to view the weather in standby mode).
5. Press **OK** to confirm.

For more options select an existing entry, and press **Options** → **Edit or Delete.**





























## Additional functions





### Display status symbols

 Signal strength	 No network coverage
 Ring only	 Data transmission

 Ring + vibration	 Alarm active
 Vibration only	 Battery level
 Silent	 Call divert activated
 Roaming (in other network)	 Bluetooth on, visible to others
 Missed call	 Bluetooth on, invisible to others
 Headset connected	 Bluetooth connected
 Voice mail message received	 Unread text message/SMS
 Unread e-mail	 Unread picture message/MMS

## Display main symbols

 Mute	 Charger connected
 Message sending success	 Charger removed
 Message sending failed	 Headset in
 Error	 Headset out
 Warning	 Speaker on
 Query	 Speaker off
 Done (confirmed)	 Incoming call
 New message	 Outgoing call
 Battery level low	 Call ended
 Searching	 Missed call. Press <b>Read</b> to see the missed calls.
 vCard message	 Call on-hold
 Volume control	 SOS calls only
 Processing, please wait	 Assistance button call
 SMS/MMS unread	 SMS/MMS read

 SMS/MMS unsent	 SMS/MMS sent
 E-mail without and with attachment unread	 E-mail without and with attachment read

## Reset settings

1. Press **Menu** → **Settings** → **Security**.
2. Select **Reset settings** to reset the phone settings. All the changes that you have made to the phone settings will be reset to default settings.
3. Enter the phone code and press **OK** to reset.

**Tip:** The default phone code is **1234**.

## Reset all

1. Press **Menu** → **Settings** → **Security**.
2. Select **Reset all** to delete phone settings and content such as contacts, number lists and messages (SIM memory is not affected).
3. Enter the phone code and press **OK** to reset.

**Tip:** The default phone code is **1234**.

## Safety instructions



### CAUTION

The unit and the accessories can contain small parts. Keep all of the equipment out of the reach of small children.

The mains adapter is the disconnect device between the product and mains power.

The mains socket outlet must be close to the equipment and easily accessible.

## Network services and costs

Your device is approved for use on the WCDMA 900/2100 MHz, GSM 900/1800/1900 MHz networks. To use the device, you need a subscription with a service provider.

Using network services may result in traffic costs. Some product features require support from the network, and you may need to subscribe to them.

## Operating environment

Follow the rules and laws that apply wherever you are, and always turn off the unit whenever its use is prohibited or can cause interference or hazards. Only use the unit in its normal user position.

Parts of the unit are magnetic. The unit can attract metal objects. Do not keep credit cards or other magnetic media near the unit. There is a risk that information stored on them can be erased.

## Medical units

The use of equipment that transmits radio signals, for example, mobile phones, can interfere with insufficiently protected medical equipment. Consult a doctor or the manufacturer of the equipment to determine if it has adequate protection against external radio signals, or if you have any questions. If notices have been put up at health care facilities instructing you to turn off the unit while you are there, you should comply. Hospitals and other health care facilities sometimes use equipment that can be sensitive to external radio signals.

## Implanted medical devices

To avoid potential interference, manufacturers of implanted medical devices recommend a minimum separation of 15 cm between a wireless device and the medical device. Persons who have such devices should:

- Always keep the wireless device more than 15 cm from the medical device.
- Should not carry the phone in a breast pocket.
- Hold the wireless device to the ear opposite the medical device.

If you have any reason to suspect that interference is taking place, turn the phone off immediately. If you have any questions about using your wireless device with an implanted medical device, consult your health care provider.

## Areas with explosion risk

Always turn off the unit when you are in an area where there is a risk of explosion. Follow all signs and instructions. There is a risk of explosion in places that include areas where you are normally requested to turn off your car engine. In these areas, sparks can cause explosion or fire which can lead to personal injury or even death.

Turn off the unit at filling stations, and any other place that has fuel pumps and auto repair facilities.

Follow the restrictions that apply to the use of radio equipment near places where fuel is stored and sold, chemical factories and places where blasting is in progress.

Areas with risk for explosion are often – but not always – clearly marked. This also applies to below decks on ships; the transport or storage of chemicals; vehicles that use liquid fuel (such as propane or butane); areas where the air contains chemicals or particles, such as grain, dust or metal powder.

## Li-ion battery

This product contains a Li-ion battery. There is a risk of fire and burns if the battery pack is handled improperly.

**WARNING**

Danger of explosion if battery is incorrectly replaced. To reduce risk of fire or burns, do not disassemble, crush, puncture, short external contacts, expose to temperature above 60° C (140° F), or dispose of in fire or water. Recycle or dispose of used batteries according to the local regulations or reference guide supplied with your product.

## Protect your hearing

This device has been tested to comply with the Sound Pressure Level requirement laid down in the applicable EN 50332-1 and/or EN 50332-2 standards.

**WARNING**

Excessive exposure to loud sounds can cause hearing damage. Exposure to loud sounds while driving may distract your attention and cause an accident. Listen to a headset at a moderate level, and do not hold the device near your ear when the loudspeaker is in use.

## Emergency calls

**IMPORTANT!**

Mobile phones use radio signals, the mobile phone network, the terrestrial network and user-programmed functions. This means that connection cannot be guaranteed in all circumstances. Therefore, never rely only on a mobile phone for very important calls such as medical emergencies.

## GPS/Location based functions

Some products provide GPS/Location based functions. Location determining functionality is provided “As is”. No representation or warranty are made as to the accuracy of such location information. Use of location-based information by the device may not be uninterrupted or error free and may additionally be dependent on network service availability. Please note that functionality may be reduced or prevented in certain environments such as building interiors or areas adjacent to buildings.

**CAUTION**

Do not use GPS functionality in a manner which causes distraction from driving.

## Vehicles

Radio signals can affect electronic systems in motor vehicles (for example, electronic fuel injection, ABS brakes, automatic cruise control, air bag systems) that have been incorrectly installed or are inadequately protected. Contact the manufacturer or its representative for more information about your vehicle or any additional equipment.

Do not keep or transport flammable liquids, gases or explosives together with the unit or its accessories. For vehicles equipped with air bags: Remember that air bags fill with air with considerable force.

Do not place objects, including fixed or portable radio equipment in the area above the airbag or the area where it might expand. Serious injuries may be caused if the mobile phone equipment is incorrectly installed and the airbag fills with air.

It is prohibited to use the unit in flight. Turn off the unit before you board a plane. Using wireless telecom units inside a plane can pose risks to air safety and interfere with telecommunications. It may also be illegal.

## Protect your personal data

Protect your personal data and prevent leakage or misuse of sensitive information

- While using your device, be sure to back up important data.
- When disposing of your device, back up all data and then reset your device to prevent misuse of your personal information.
- Carefully read the permissions screen when downloading applications. Be particularly cautious with applications that have access to many functions or to a significant amount of your personal information.
- Check your accounts regularly for unapproved or suspicious use. If you find any sign of misuse of your personal information, contact your service provider to delete or change your account information.
- In the event your device is lost or stolen, change the passwords on your accounts to protect your personal information.
- Avoid using applications from unknown sources and lock your device with a pattern, password, or PIN.

## Malware and viruses

To protect your device from malware and viruses, follow these usage tips. Failure to do so may result in damages or loss of data that may not be covered by the warranty service.

- Do not download unknown applications.
- Do not visit untrusted websites.
- Delete suspicious messages or email from unknown senders.
- Set a password and change it regularly.
- Deactivate wireless features, such as Bluetooth, when not in use.
- If the device behaves abnormally, run an antivirus program to check for infection.
- Run an antivirus program on your device before you launch newly-downloaded applications and files.
- Do not edit registry settings or modify the device's operating system.



## Care and maintenance

Your unit is a technically advanced product and should be treated with the greatest care. Negligence may void the warranty.

- Protect the unit from moisture. Rain, snow, humidity, and all types of liquids can contain substances that corrode the electronic circuits. If the unit gets wet, you should immediately power off the phone, remove the battery and allow the unit to dry completely before you replace it.
- Do not use or keep the unit in dusty, dirty environments. The unit's moving parts and electronic components can be damaged.
- Do not keep the unit in warm places. High temperatures can reduce the lifespan for electronic equipment, damage batteries and distort or melt certain plastics.
- Do not keep the unit in cold places. When the unit warms up to normal temperature, condensation can form on the inside and can damage the electronic circuits.
- Do not try to open the unit in any other way than that which is indicated here.
- Do not drop or shake the unit. If it is treated roughly the circuits and precision mechanics can be broken.
- Do not use strong chemicals to clean the unit.
- Do not disassemble, open, crush, bend, deform, puncture or shred.
- Do not modify or remanufacture, attempt to insert foreign objects into the battery, immerse or expose to water or other liquids, expose to fire, explosion or other hazard.
- Only use the battery for the system for which it is specified.
- Only use the battery with a charging system that has been qualified with the system per IEEE-Std-1725. Use of an unqualified battery or charger may present a risk of fire, explosion, leakage, or other hazard.
- Do not short circuit a battery or allow metallic conductive objects to contact battery terminals.
- Replace the battery only with another battery that has been qualified with the system per this standard, IEEE-Std-1725. Use of an unqualified battery may present a risk of fire, explosion, leakage or other hazard.
- Promptly dispose of used batteries in accordance with local regulations.
- Battery usage by children should be supervised.
- Improper battery use may result in a fire, explosion or other hazard.

For devices that utilize a USB port as a charging source, the device's user manual shall include a statement that the device shall only be connected to CTIA certified adapters, products that bear the USB-IF logo or products that have completed the USB-IF compliance program.

The advice applies to the unit, battery, power adapter and other accessories. If the phone is not working as it should, please contact the place of purchase for service. Don't forget the receipt or a copy of the invoice.

## Warranty

This product is guaranteed for a period of 24 months from the date of purchase. In the unlikely event of a fault occurring during this period, please contact the place of purchase. Proof of purchase is required for any service or support needed during the guarantee period.

This guarantee will not apply to a fault caused by an accident or a similar incident or damage, liquid ingress, negligence, abnormal usage, non-maintenance or any other circumstances on the user's part. Furthermore, this guarantee will not apply to any fault caused by a thunderstorm or any other voltage fluctuations. As a matter of precaution, we recommend disconnecting the charger during a thunderstorm.

Please note that this is a voluntary manufacturer's warranty and provides rights in addition to, and does not affect statutory rights of end-users.

Batteries are consumables and are not included in any guarantee.

This guarantee does not apply if batteries other than DORO original batteries are used.

## Specifications

<b>Network:</b>	WCDMA 900/2100 MHz, GSM 900/1800/1900 MHz
<b>Dimensions</b>	104 mm x 55 mm x 19 mm
<b>Weight</b>	105 g (including battery)
<b>Battery</b>	3.7 V / 800 mAh Li-ion battery
<b>Operating ambient temperature</b>	Min: 0° C (32° F) Max: 40° C (104° F)
<b>Charging ambient temperature</b>	Min: 0° C (32° F) Max: 40° C (104° F)
<b>Storage temperature</b>	Min: -20° C (-4° F) Max: 60° C (140° F)

## Copyright and other notices

Bluetooth® is a registered trademark of Bluetooth SIG, Inc.

vCard is a trademark of the Internet Mail Consortium.

eZiType™ is a trademark of Zi Corporation.

Wi-Fi is a trademark or a registered trademark of the Wi-Fi Alliance.

microSD is a trademark of SD Card Association.

Java, J2ME and all other Java-based marks are trademarks or registered trademarks of Sun Microsystems, Inc. in the United States and other countries.

The contents of this document are provided "as is". Except as required by applicable law, no warranties of any kind, either express or implied, including, but not limited to, the implied warranties of merchantability and fitness for a particular purpose, are made in relation to the accuracy, reliability or contents of this document. Doro reserves the right to revise this document or withdraw it at any time without prior notice.

Google, Google Maps™, Gmail, Google Calendar, Google Checkout, Hangouts, YouTube, the YouTube logo, Picasa and Android are trademarks or registered trademarks of Google, Inc.

This product is licensed under the MPEG-4 visual and AVC patent portfolio licenses for the personal and noncommercial use of a consumer for (i) encoding video in compliance with the MPEG-4 visual standard ("MPEG-4 video") or the AVC standard ("AVC video") and/or (ii) decoding MPEG-4 or AVC video that was encoded by a consumer engaged in a personal and non-commercial activity and/or was obtained from a video provider licensed by MPEG LA to provide MPEG-4 and/or AVC video. No license is granted or shall be implied for any other use. Additional information including that relating to promotional, internal and commercial uses and licensing may be obtained from MPEG LA, L.L.C. See [www.mpegla.com](http://www.mpegla.com). MPEG Layer-3 audio decoding technology licensed from Fraunhofer IIS and Thomson.

Other product and company names mentioned herein may be the trademarks of their respective owners.

Any rights not expressly granted herein are reserved. All other trademarks are property of their respective owners.

To the maximum extent permitted by applicable law, under no circumstances shall Doro or any of its licensors be responsible for any loss of data or income or any special, incidental, consequential or indirect damages howsoever caused.

Doro does not provide a warranty for or take any responsibility for the functionality, content, or end-user support of third-party apps provided with your device. By using an app, you acknowledge that the app is provided as is. Doro does not make any representations, provide a warranty, or take any responsibility for the functionality, content, or end-user support of third-party apps provided with your device.

## **Content copyright**

The unauthorised copying of copyrighted materials is contrary to the provisions of the Copyright Laws of the United States and other countries. This device is intended solely for copying non-copyrighted materials, materials in which you own the copyright, or materials which you are authorised or legally permitted to copy. If you are uncertain about your right to copy any material, please contact your legal advisor.

## **Open source licenses**

You are entitled to receive a copy of the source code of software licensed under an open source license that gives you the right to receive the source code for that software (for example GPL or LGPL) to you on an appropriate media, against an administrative fee covering Doro AB's cost for handling the distribution and costs for media. Please direct such request to Doro AB, Open Source Software Operations, Magistratsvagen 10, SE 226 43 Lund, Sweden. To be valid, such a request must be made within three (3) years from the date of the distribution of this product by Doro AB, or in the case of code licensed under the GPL v3 for as long as Doro AB offers spare parts or customer support for this product model.

---

## Hearing aid compatibility

**Note!** For hearing aid compatibility, turn off Bluetooth connectivity.

This phone is hearing aid compatible. Hearing aid compatibility is not a guarantee that a specific hearing aid will work with a specific phone. Mobile phones contain radio transmitters that may interfere with hearing aid performance. This phone has been tested for use with hearing aids, for some of the wireless technologies that it uses, but there may be some newer wireless technologies that have not been tested yet for use with hearing aids. To ensure that a specific hearing aid works well with this phone, test them together before making a purchase.

The standard for hearing aid compatibility contains two types of ratings:

- **M:** To use your hearing aid in this mode, make sure that your hearing aid is set to "M-mode" or acoustic coupling mode, and position the phone's receiver near the hearing aid's built-in microphone. For the best results, try using the phone in different positions relative to your hearing aid—for example, placing the receiver slightly above the ear may result in better performance for hearing aids with microphones positioned behind the ear.
- **T:** To use your hearing aid in this mode, make sure that your hearing aid is set to "T-mode" or telecoil coupling mode (not all hearing aids have this mode). For the best results, try using the phone in different positions relative to your hearing aid—for example, placing the receiver slightly below or in front of the ear may result in better performance.

Your device meets the M4/T4 level rating.

## Specific Absorption Rate (SAR)

This device meets applicable international safety requirements for exposure to radio waves. Your mobile device is a radio transmitter and receiver. It is designed not to exceed the limits for exposure to radio waves (radio frequency electromagnetic fields) recommended by international guidelines from the independent scientific organization ICNIRP (International Commission of Non-Ionizing Radiation Protection).

The radio wave exposure guidelines use a unit of measurement known as the Specific Absorption Rate, or SAR. The SAR limit for mobile devices is 2 W/kg averaged over 10 grams of tissue and include a substantial safety margin designed to assure the safety of all persons, regardless of age and health.

Tests for SAR are conducted using standard operating positions with the device transmitting at its highest certified power level in all tested frequency bands. The highest SAR values under the ICNIRP guidelines for this device model are:

**Head SAR:** 0.61 W/kg

**Body SAR:** 1.98 W/kg

During normal use, the SAR values for this device are usually well below the values stated above. This is because, for purposes of system efficiency and to minimize interference on the network, the output power of your mobile device is automatically decreased

when full power is not needed for the call. The lower the power output of the device, the lower its SAR value.

This device meets RF exposure guidelines when used against the head or when positioned at least 0.5 cm away from the body. When a carry case, belt clip or other form of device holder is used for body-worn operation, it should not contain metal and should provide at least the above stated separation distance from the body.

The World Health Organization (WHO) has stated that current scientific information does not indicate the need for any special precautions when using mobile devices. If you are interested in reducing your exposure, they recommend you reduce your usage or use a hands-free accessory to keep the device away from your head and body.

## Correct disposal of this product



(Waste Electrical & Electronic Equipment)  
(Applicable in countries with separate collection systems)



This marking on the product, accessories or manual indicates that the product and its electronic accessories (e.g. charger, headset, USB cable) should not be disposed of with other household waste. To prevent possible harm to the environment or human health from uncontrolled waste disposal, please separate these items from other types of waste and recycle them responsibly to promote the sustainable reuse of material resources. Household users should contact either the retailer where they purchased this product, or their local government office, for details of where and how they can take these items for environmentally safe recycling. Business users should contact their supplier and check the terms and conditions of the purchase contract. This product and its electronic accessories should not be mixed with other commercial wastes for disposal. This product is RoHS compliant.

## Correct disposal of batteries in this product



(Applicable in countries with separate collection systems)

The marking on the battery, manual or packaging indicates that the battery in this product should not be disposed of with other household waste. Where marked, the chemical symbols Hg, Cd or Pb indicate that the battery contains mercury, cadmium or lead above the reference levels in EC Directive 2006/66. If batteries are not properly disposed of, these substances can cause harm to human health or the environment.

To protect natural resources and to promote material reuse, please separate batteries from other types of waste and recycle them through your local, free battery return system.

---

## Declaration of Conformity

Doro hereby declares that Doro 6520 conforms to the essential requirements and other relevant regulations contained in the Directives 1999/5/EC (R&TTE) and 2011/65/EU (RoHS). A copy of the Declaration of Conformity is available at [www.doro.com/dofc](http://www.doro.com/dofc).

### FCC

#### FCC notice

This device complies with part 15 of the FCC Rules. Operation is subject to the following two conditions: (1) This device may not cause harmful interference, and (2) this device must accept any interference received, including interference that may cause undesired operation.

This equipment has been tested and found to comply with the limits for a Class B digital device, pursuant to part 15 of the FCC Rules. These limits are designed to provide reasonable protection against harmful interference in a residential installation. This equipment generates, uses and can radiate radio frequency energy and, if not installed and used in accordance with the instructions, may cause harmful interference to radio communications. However, there is no guarantee that interference will not occur in a particular installation. If this equipment does cause harmful interference to radio or television reception, which can be determined by turning the equipment off and on, the user is encouraged to try to correct the interference by one or more of the following measures:

- Reorient or relocate the receiving antenna.
- Increase the separation between the equipment and the receiver.
- Connect the equipment to an outlet on a circuit different from that to which the receiver is connected.
- Consult the dealer or an experienced radio/TV technician for help.

The FCC can require you to stop using your unit if such interference cannot be eliminated.

Doro has not approved any changes or modifications to this device by the user. Any changes or modifications could void the user's authority to operate the equipment.

#### RF exposure information (SAR)

##### THIS DEVICE MEETS FCC LIMITS FOR EXPOSURE TO RADIO WAVES

Your mobile device is a radio transmitter and receiver. It is designed not to exceed the limits for exposure to radio waves (radio frequency electromagnetic fields) adopted by the Federal Communications Commission (FCC). These limits include a substantial safety margin designed to assure the safety of all persons, regardless of age and health.

The radio wave exposure guidelines use a unit of measurement known as the Specific Absorption Rate, or SAR. The SAR limit for mobile devices is 1.6 W/kg.

Tests for SAR are conducted using standard operating positions with the device transmitting at its highest certified power level in all tested frequency bands. The highest SAR values under the FCC guidelines for this device model are:

**Head SAR:** 0.213 W/kg

**Body SAR:** 0.395 W/kg

During use, the actual SAR values for this device are usually well below the values stated above. This is because, for purposes of system efficiency and to minimize interference on the network, the operating power of your mobile device is automatically decreased when full power is not needed for the call. The lower the power output of the device, the lower its SAR value.

Body-worn SAR testing has been carried out at a separation distance of 1.0 cm. To meet RF exposure guidelines during body-worn operation, the device should be positioned at least this distance away from the body.

Organizations such as the World Health Organization and the US Food and Drug Administration have suggested that if people are concerned and want to reduce their exposure, they could use a hands-free accessory to keep the wireless device away from the head and body during use, or reduce the amount of time spent using the device.

While there may be differences between the SAR levels of various phones and at various positions, they all meet the government requirement. The FCC has granted an Equipment Authorization for this model phone with all reported SAR levels evaluated as in compliance with the FCC RF exposure guidelines. SAR information on this model phone is on file with the FCC and can be found under the Display Grant section of <http://www.fcc.gov/oet/ea/fccid> after searching on **FCC ID: WS5DFC0050**

Doro 6520 (2011,2021,2031)

FCC ID: WS5DFC0050

English

Version 2.2

© 2016 Doro AB. All rights reserved.  
[www.doro.com](http://www.doro.com)



REV 16969 – STR 20160622